

## Features

- Ideally Suited for Automatic Insertion
- Complementary PNP Types: BC856W – BC858W
- For Switching and AF Amplifier Applications
- **Totally Lead-Free & Fully RoHS compliant (Notes 1 & 2)**
- **Halogen and Antimony Free. "Green" Device (Note 3)**
- **Qualified to AEC-Q101 Standards for High Reliability**
- **PPAP capable (Note 4)**

## Mechanical Data

- Case: SOT323
- Case material: molded plastic, "Green" molding compound  
UL Flammability Classification Rating 94V-0
- Moisture Sensitivity: Level 1 per J-STD-020
- Terminals: Finish – Matte Tin Plated Leads, Solderable per MIL-STD-202, Method 208
- Weight: 0.006 grams (Approximate)



Top View

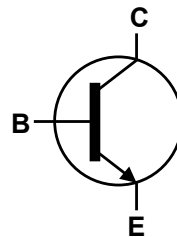

Device Symbol

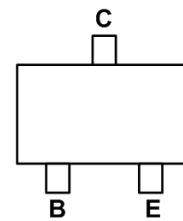
 Top View  
Pin-Out

## Ordering Information (Notes 4 & 5)

Product	Compliance	Marking	Reel Size (inches)	Quantity per Reel
BC846AW-7-F	AEC-Q101	K1Q	7	3,000
BC846BW-7-F	AEC-Q101	K1R	7	3,000
BC846BWQ-7-F	Automotive	K1R	7	3,000
BC846BW-13-F	AEC-Q101	K1R	13	10,000
BC847AW-7-F	AEC-Q101	K1Q	7	3,000
BC847BW-7-F	AEC-Q101	K1R	7	3,000
BC847BW-13-F	AEC-Q101	K1R	13	10,000

Product	Compliance	Marking	Reel Size (inches)	Quantity per Reel
BC847BWQ-13-F	Automotive	K1R	13	10,000
BC847CW-7-F	AEC-Q101	K1M	7	3,000
BC847CW-13-F	AEC-Q101	K1M	13	10,000
BC847CWQ-7-F	Automotive	K1M	7	3,000
BC848AW-7-F	AEC-Q101	K1Q	7	3,000
BC848BW-7-F	AEC-Q101	K1R	7	3,000
BC848CW-7-F	AEC-Q101	K1M	7	3,000

- Notes:
1. No purposely added lead. Fully EU Directive 2002/95/EC (RoHS) & 2011/65/EU (RoHS 2) compliant.
  2. See [http://www.diodes.com/quality/lead\\_free.html](http://www.diodes.com/quality/lead_free.html) for more information about Diodes Incorporated's definitions of Halogen- and Antimony-free, "Green" and Lead-free.
  3. Halogen- and Antimony-free "Green" products are defined as those which contain <900ppm bromine, <900ppm chlorine (<1500ppm total Br + Cl) and <1000ppm antimony compounds.
  4. Automotive products are AEC-Q101 qualified and are PPAP capable. Automotive, AEC-Q101 and standard products are electrically and thermally the same, except where specified. For more information, please refer to [http://www.diodes.com/quality/product\\_compliance\\_definitions/](http://www.diodes.com/quality/product_compliance_definitions/).
  5. Tape width is 8mm. For packaging details, go to our website at <http://www.diodes.com/products/packages.html>

## Marking Information

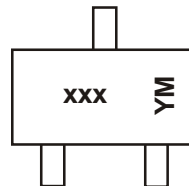

xxx = Product Type Marking Code  
(Please see Ordering Information)  
YM = Date Code Marking  
Y or  $\bar{Y}$  = Year (ex: A = 2013)  
M or  $\bar{M}$  = Month (ex: 9 = September)

### Date Code Key

Year	2010	2011	2012	2013	2014	2015	2016	2017
Code	X	Y	Z	A	B	C	D	E

Month	Jan	Feb	Mar	Apr	May	Jun	Jul	Aug	Sep	Oct	Nov	Dec
Code	1	2	3	4	5	6	7	8	9	O	N	D

**Absolute Maximum Ratings** (@ $T_A = +25^\circ\text{C}$ , unless otherwise specified.)

Characteristic		Symbol	Value	Unit
Collector-Base Voltage	BC846	$V_{CBO}$	80	V
	BC847		50	
	BC848		30	
Collector-Emitter Voltage	BC846	$V_{CEO}$	65	V
	BC847		45	
	BC848		30	
Emitter-Base Voltage	BC846, BC847	$V_{EBO}$	6	V
	BC848		5	
Continuous Collector Current		$I_C$	100	mA
Peak Collector Current		$I_{CM}$	200	mA
Peak Base Current		$I_{BM}$	200	mA

**Thermal Characteristics** (@ $T_A = +25^\circ\text{C}$ , unless otherwise specified.)

Characteristic		Symbol	Value	Unit
Power Dissipation	(Note 6)	$P_D$	200	mW
Thermal Resistance, Junction to Ambient	(Note 6)	$R_{\theta JA}$	625	$^\circ\text{C}/\text{W}$
Operating and Storage Temperature Range		$T_J, T_{STG}$	-65 to +150	$^\circ\text{C}$

**ESD Ratings** (Note 7)

Characteristic	Symbol	Value	Unit	JEDEC Class
Electrostatic Discharge - Human Body Model	ESD HBM	4,000	V	3A
Electrostatic Discharge - Machine Model	ESD MM	400	V	C

- Notes:
6. For a device mounted on minimum recommended pad layout 1oz weight copper that is on a single-sided FR4 PCB; device is measured under still air conditions whilst operating in a steady-state.
  7. Refer to JEDEC specification JESD22-A114 and JESD22-A115.

**Electrical Characteristics** (@ $T_A = +25^\circ\text{C}$ , unless otherwise specified.)

Characteristic		Symbol	Min	Typ	Max	Unit	Test Condition
Collector-Base Breakdown Voltage	BC846	$BV_{CBO}$	80	—	—	V	$I_C = 100\mu\text{A}$
	BC847		50				
	BC848		30				
Collector-Emitter Breakdown Voltage (Note 8)	BC846	$BV_{CEO}$	65	—	—	V	$I_C = 10\text{mA}$
	BC847		45				
	BC848		30				
Emitter-Base Breakdown Voltage	BC846, BC847	$BV_{EBO}$	6	—	—	V	$I_E = 100\mu\text{A}$
	BC848		5				
DC Current Gain (Note 8)	Current Gain Group	A	110	180	220	—	$V_{CE} = 5.0\text{V}, I_C = 2.0\text{mA}$
		B	200	290	450		
		C	420	520	800		
Collector Cutoff Current		$I_{CBO}$	—	—	20	nA	$V_{CB} = 30\text{V}$
					5	$\mu\text{A}$	$V_{CB} = 30\text{V}, T_A = +150^\circ\text{C}$
Collector-Emitter Saturation Voltage (Note 8)		$V_{CE(sat)}$	—	90	250	mV	$I_C = 10\text{mA}, I_B = 0.5\text{mA}$
				200	600		$I_C = 100\text{mA}, I_B = 5.0\text{mA}$
Base-Emitter Turn-On Voltage (Note 8)		$V_{BE(on)}$	580	660	700	mV	$I_C = 2\text{mA}, V_{CE} = 5\text{V}$
			—	—	770		$I_C = 10\text{mA}, V_{CE} = 5\text{V}$
Base-Emitter Saturation Voltage (Note 8)		$V_{BE(sat)}$	—	700	—	mV	$I_C = 10\text{mA}, I_B = 0.5\text{mA}$
				900			$I_C = 100\text{mA}, I_B = 5\text{mA}$
Output Capacitance		$C_{obo}$	—	3	4.5	pF	$V_{CB} = 10\text{V}, f = 1.0\text{MHz}$
Transition Frequency		$f_T$	100	300	—	MHz	$V_{CE} = 5\text{V}, I_C = 10\text{mA}, f = 100\text{MHz}$
Noise Figure		NF	—	—	10	dB	$V_{CE} = 5\text{V}, I_C = 200\mu\text{A}$ $R_S = 2\text{k}\Omega, f = 1\text{kHz}$ $\Delta f = 200\text{Hz}$

Notes: 8. Measured under pulsed conditions. Pulse width  $\leq 300\mu\text{s}$ . Duty cycle  $\leq 2\%$ .

**Typical Electrical Characteristics** (@ $T_A = +25^\circ\text{C}$ , unless otherwise specified.)

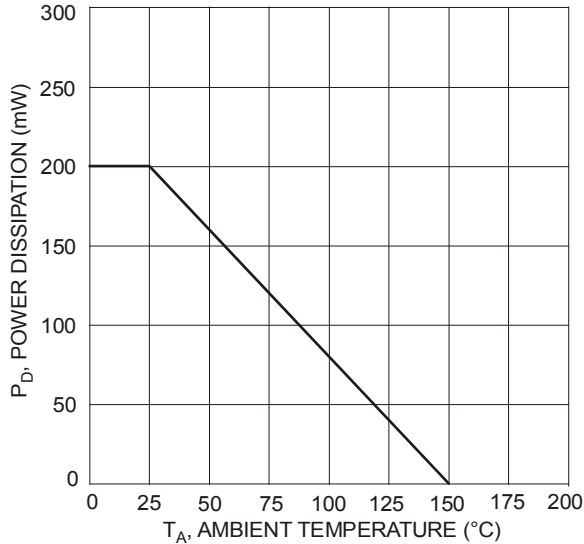

Figure 1 Power Dissipation vs. Ambient Temperature

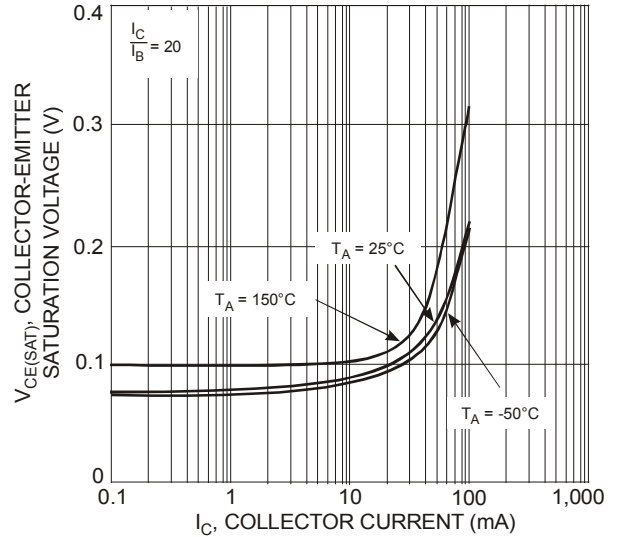

Figure 2 Typical Collector-Emitter Saturation Voltage vs. Collector Current

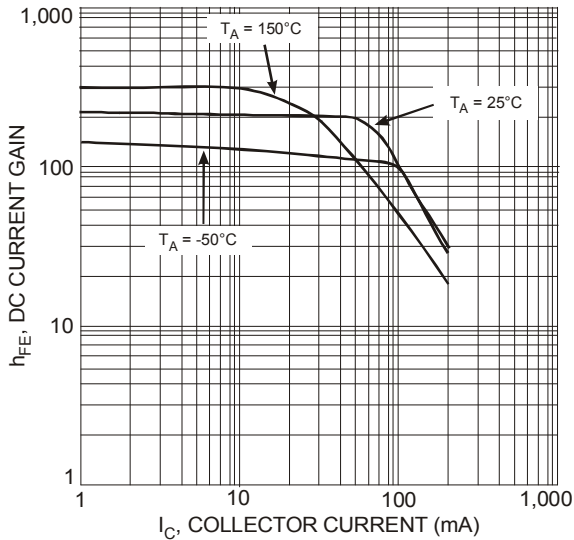

Figure 3 Typical DC Current Gain vs. Collector Current

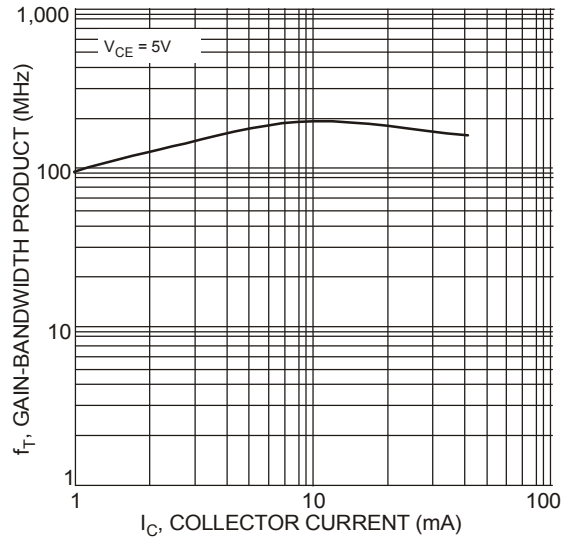
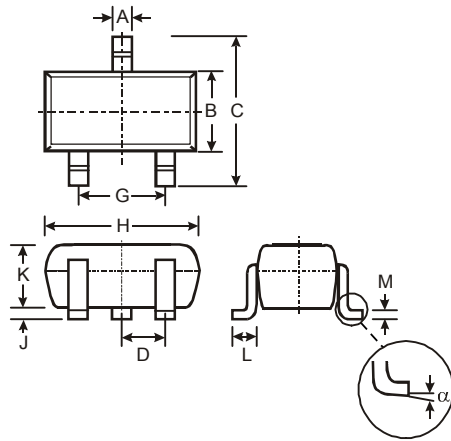

Figure 4 Typical Gain-Bandwidth Product vs. Collector Current

**Package Outline Dimensions**

Please see AP02002 at <http://www.diodes.com/datasheets/ap02002.pdf> for latest version.



SOT323			
Dim	Min	Max	Typ
A	0.25	0.40	0.30
B	1.15	1.35	1.30
C	2.00	2.20	2.10
D	—	—	0.65
G	1.20	1.40	1.30
H	1.80	2.20	2.15
J	0.0	0.10	0.05
K	0.90	1.00	1.00
L	0.25	0.40	0.30
M	0.10	0.18	0.11
α	0°	8°	—
All Dimensions in mm			

**Suggested Pad Layout**

Please see AP02001 at <http://www.diodes.com/datasheets/ap02001.pdf> for the latest version.

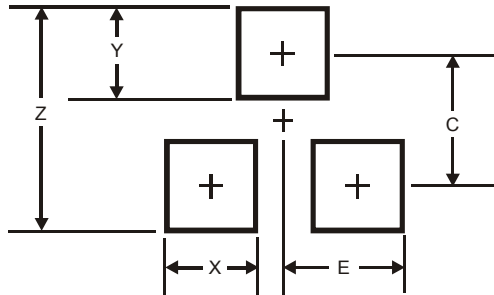

Dimensions	Value (in mm)
Z	2.8
X	0.7
Y	0.9
C	1.9
E	1.0

**IMPORTANT NOTICE**

DIODES INCORPORATED MAKES NO WARRANTY OF ANY KIND, EXPRESS OR IMPLIED, WITH REGARDS TO THIS DOCUMENT, INCLUDING, BUT NOT LIMITED TO, THE IMPLIED WARRANTIES OF MERCHANTABILITY AND FITNESS FOR A PARTICULAR PURPOSE (AND THEIR EQUIVALENTS UNDER THE LAWS OF ANY JURISDICTION).

Diodes Incorporated and its subsidiaries reserve the right to make modifications, enhancements, improvements, corrections or other changes without further notice to this document and any product described herein. Diodes Incorporated does not assume any liability arising out of the application or use of this document or any product described herein; neither does Diodes Incorporated convey any license under its patent or trademark rights, nor the rights of others. Any Customer or user of this document or products described herein in such applications shall assume all risks of such use and will agree to hold Diodes Incorporated and all the companies whose products are represented on Diodes Incorporated website, harmless against all damages.

Diodes Incorporated does not warrant or accept any liability whatsoever in respect of any products purchased through unauthorized sales channel. Should Customers purchase or use Diodes Incorporated products for any unintended or unauthorized application, Customers shall indemnify and hold Diodes Incorporated and its representatives harmless against all claims, damages, expenses, and attorney fees arising out of, directly or indirectly, any claim of personal injury or death associated with such unintended or unauthorized application.

Products described herein may be covered by one or more United States, international or foreign patents pending. Product names and markings noted herein may also be covered by one or more United States, international or foreign trademarks.

This document is written in English but may be translated into multiple languages for reference. Only the English version of this document is the final and determinative format released by Diodes Incorporated.

**LIFE SUPPORT**

Diodes Incorporated products are specifically not authorized for use as critical components in life support devices or systems without the express written approval of the Chief Executive Officer of Diodes Incorporated. As used herein:

A. Life support devices or systems are devices or systems which:

1. are intended to implant into the body, or
2. support or sustain life and whose failure to perform when properly used in accordance with instructions for use provided in the labeling can be reasonably expected to result in significant injury to the user.

B. A critical component is any component in a life support device or system whose failure to perform can be reasonably expected to cause the failure of the life support device or to affect its safety or effectiveness.

Customers represent that they have all necessary expertise in the safety and regulatory ramifications of their life support devices or systems, and acknowledge and agree that they are solely responsible for all legal, regulatory and safety-related requirements concerning their products and any use of Diodes Incorporated products in such safety-critical, life support devices or systems, notwithstanding any devices- or systems-related information or support that may be provided by Diodes Incorporated. Further, Customers must fully indemnify Diodes Incorporated and its representatives against any damages arising out of the use of Diodes Incorporated products in such safety-critical, life support devices or systems.

Copyright © 2013, Diodes Incorporated

[www.diodes.com](http://www.diodes.com)